

# OMEGA

## VALVOLA A SFERA A PASSAGGIO TOTALE PER GAS COMBUSTIBILI FULL BORE BALL VALVE FOR FUEL GAS



### SPECIFICA MATERIALI MATERIAL SPECIFICATION



EN 331  
(MOP5)

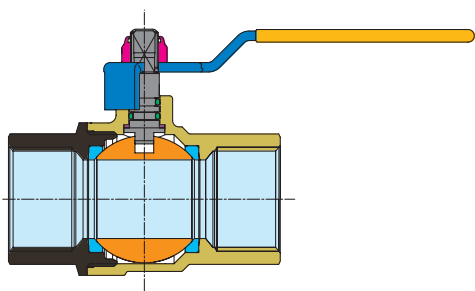

GUARDA IL VIDEO / WATCH THE VIDEO



### PARTICOLARI COMPONENT COMPONENT

- CORPO BODY
- MANICOTTO END ADAPTER
- SFERA BALL
- SEDI LATERALI BALL GASKETS
- PERNO STEM
- ANELLO ANTIFRIZIONE THRUST WASHER
- O-RINGS
- LEVA LEVER HANDL
- FARFALLA O LEVA LEVER OR T-HANDL
- DADO AUTO-BLOCCANTE SELF-LOCKING NUT

### MATERIALI MATERIAL

- CW 617 N UNI EN 12165
- CW 617 N UNI EN 12165
- CW 614 N UNI EN 12164
- PTFE
- CW 614 N UNI EN 12164
- PTFE
- HNBR
- ACCIAIO ZINCATO Zinc-Plated Steel
- ALLUMINIO Aluminium
- ACCIAIO ZINCATO Zinc-Plated Steel

### DESCRIZIONE DESCRIPTION

- STAMPATO DA BARRA, NICHELATO Forged, Nickel-Plated
- STAMPATO DA BARRA, NICHELATO Forged, Nickel-Plated
- DA BARRA, NICHEL-CROMATA Machined, Chrome-Plated
- VERGINE Virgin
- DA BARRA Machined
- VERGINE Virgin
- FLUIDI COMPATIBILI GAS Fluids compatible gas
- PLASTIFICATA IN PVC Pvc Insulated
- VERNICIATA Painted
- ZINCATO Zinc-Plated

### FILETTATURE

Estremità filettate UNI EN 10226

### IMPIEGHI

Gas combustibili:  
1°- 2°-3° famiglia  
e altri fluidi compatibili  
con i materiali della valvola

### PRESSIONE DI ESERCIZIO

Per gas combustibili MOP5.  
Per altri usi da PN 80 (1/4") a PN 16 (4").  
Vedere diagramma pressione/temperatura.

### LIMITI DI TEMPERATURA

Per gas combustibili da -20°C a +60°C.  
Per altri usi da -20°C a +130°C.  
Vedere diagramma pressione/temperatura.

### END CONNECTIONS

Threaded ends to UNI EN 10226

### APPLICATIONS

Fuel gas:  
1st - 2nd -3rd family  
and other fluids compatible  
with the valve materials

### PRESSURE LIMITS

For fuel gas 1°, 2° e 3° family MOP5.  
For other uses from PN 80 (1/4") to PN 16 (size 4").  
See pressure/temperature diagram.

### TEMPERATURE LIMITS

For fuel gas from -20°C to +60°C.  
For other uses from -20°C to + 130°C.  
See pressure/temperature diagram.

Diagramma pressione/temperatura (prova eseguita con acqua)  
Pressure/temperature diagram (tested with water)



Diagramma perdite di carico (prova eseguita con acqua)  
Loss of head diagram (tested with water)



#### S0251 OMEGA

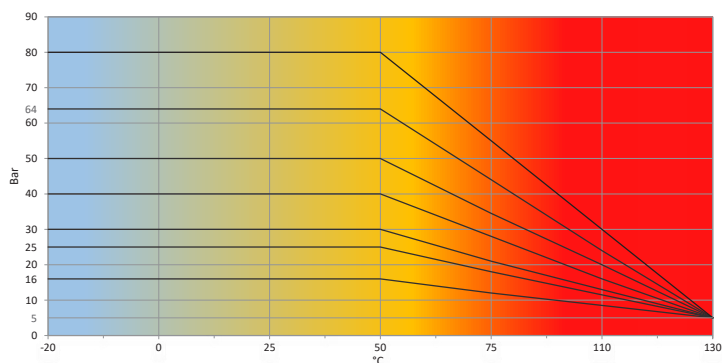
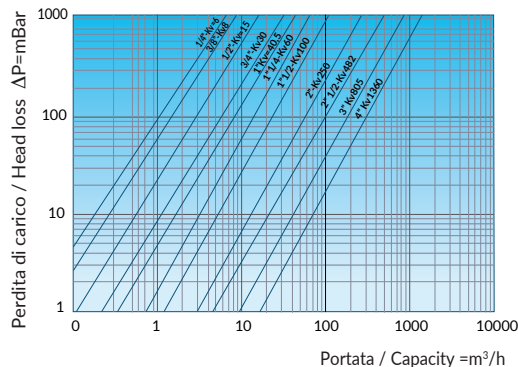
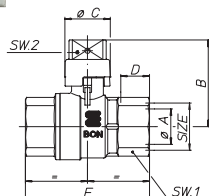

CODICE CODE	MISURA SIZE	PN Bar	øA	B	øC	D	E	SW1-2	Box Crt
S0251N34	½" (DN 15)	50	15	39,5	23	15	59,5	25-11	12/61
S0251N35	¾" (DN20)	50	20	49	25,5	16,3	70	31-12	12/48
S0251N36	1" (DN25)	50	25	53,5	25,5	19,1	83	38-12	9/36
S0251N37	1"¼ (DN32)	50	32	69,5	34,5	21,4	98,5	47-15	6/24
S0251N38	1"½ (DN40)	40	40	75,5	34,5	21,4	108	54-15	5/10
S0251N39	2" (DN50)	40	50	92,5	40,5	25,7	130	66-18	2/8

Valvola a sfera femmina/femmina a passaggio totale con cappuccio di piombatura, nichelata.  
Full bore ball valve for fuel gas with lockable rectangular head, female/female, nickel-plated.

#### S0252 OMEGA

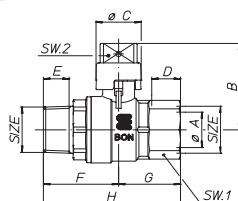
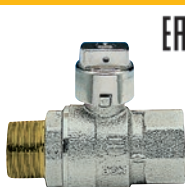

CODICE CODE	MISURA SIZE	PN Bar	øA	B	øC	D	E	F	G	H	SW1-2	Box Crt
S0252N34	½" (DN 15)	50	15	39,5	23	15	13,2	37,25	29,75	67	25-11	15/75
S0252N35	¾" (DN20)	50	20	49	25,5	16,3	14,5	41	35	76	25-11	12/60
S0252N36	1" (DN25)	50	25	53,5	25,5	19,1	16,8	47,4	41,6	89	38-12	8/40
S0252N37	1"¼ (DN32)	50	32	69,5	34,5	21,4	19,1	54	49	103	47-15	6/24
S0252N38	1"½ (DN40)	40	40	75,5	34,5	21,4	19,1	59,6	53,9	113,5	54-15	4/8
S0252N39	2" (DN50)	40	50	92,5	40,5	25,7	23,4	71,6	64,9	136,5	66-18	4/8

Valvola a sfera maschio/femmina a passaggio totale con cappuccio di piombatura, nichelata.  
Full bore ball valve with lockable rectangular head, male/female, nickel-plated.

#### S0257 OMEGA

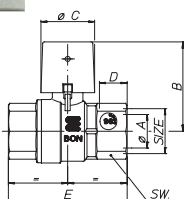
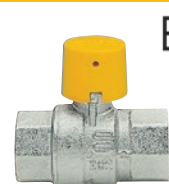

CODICE CODE	MISURA SIZE	PN Bar	øA	B	øC	D	E	SW	Box Crt
S0257N35	¾" (DN20)	50	20	52,5	31,5	16,3	70	31	12/48
S0257N36	1" (DN25)	50	25	57	31,5	19,1	83	38	9/36
S0257N37	1"¼ (DN32)	50	32	73	40,5	21,4	98,5	47	4/20
S0257N38	1"½ (DN40)	40	40	79	40,5	21,4	108	54	4/8
S0257N39	2" (DN50)	40	50	96	47,5	25,7	130	66	2/8

Valvola a sfera femmina/femmina a passaggio totale con cappuccio giallo piombabile, per colonne montanti GAS, nichelata.  
Full bore ball valve with lockable rectangular head and yellow plastic cap, female/female, nickel-plated.

#### S0258 OMEGA

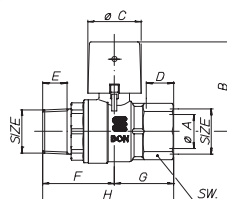
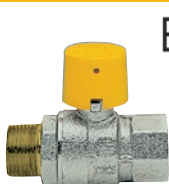

CODICE CODE	MISURA SIZE	PN Bar	øA	B	øC	D	E	F	G	H	SW	Box Crt
S0258N35	¾" (DN20)	50	20	52,5	31,5	16,3	14,5	41	35	76	31	12/48
S0258N36	1" (DN25)	50	25	57	31,5	19,1	16,8	47,4	41,6	89	38	6/30
S0258N37	1"¼ (DN32)	50	32	73	40,5	21,4	19,1	54	49	103	47	6/12
S0258N38	1"½ (DN40)	40	40	79	47,5	21,4	19,1	59,6	53,9	113,5	54	2/10
S0258N39	2" (DN50)	40	50	96	47,5	25,7	23,4	71,6	64,9	136,5	66	2/4

Valvola a sfera maschio/femmina a passaggio totale con cappuccio giallo piombabile, per colonne montanti GAS, nichelata.  
Full bore ball valve with lockable rectangular head and yellow plastic cap, male/female, nickel-plated.

# OMEGA

## VALVOLA A SFERA A PASSAGGIO TOTALE PER GAS COMBUSTIBILI

### FULL BORE BALL VALVE FOR FUEL GAS

#### S0260 OMEGA

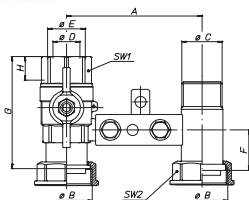

CODICE CODE	MISURA SIZE	PN Bar	A	øB	øC	øD	øE	F	G	H	SW1-2	Box Crt
S0260S20	1"x1"¼	5	110	1"¼	1"	22	1"	32,5	92	19,1	38-46	4/16
S0260S26	¾"x1"¼	5	110	1"¼	1"	17,5	¾"	32,5	73	16,2	31-46	4/16

Mensola a sfera per contatore gas interasse 110mm con zanca per fischer, con farfalla, sabbiata.

Guarnizione piana in gomma omologata per gas.

Complete bracket for gas meter 110 mm axle base, for Fischer mounting.

Flat rubber gasket for gas.

#### S0261 OMEGA

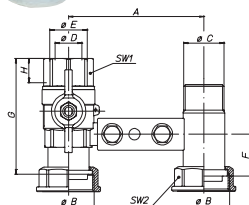
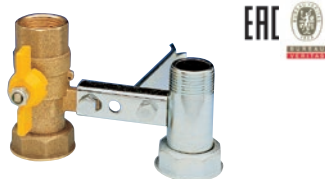

CODICE CODE	MISURA SIZE	PN Bar	A	øB	øC	øD	øE	F	G	H	SW1-2	Box Crt
S0261S20	1"x1"¼	5	110	1"¼	1"	22	1"	32,5	92	19,1	38-46	4/8
S0261S26	¾"x1"¼	5	110	1"¼	1"	17,5	¾"	32,5	73	16,2	31-46	4/8

Valvola a sfera femmina per contatore gas, con farfalla, sabbiata.

Guarnizione piana in gomma omologata per gas.

Ball valve for gas meter, female, with T-handle. Flat rubber gasket for gas.

#### S0263 OMEGA

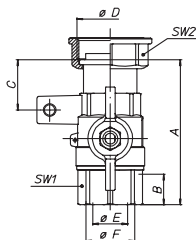

CODICE CODE	MISURA SIZE	PN Bar	A	B	C	øD	øE	øF	SW1-2	Box Crt
S0263S20	1"x1"¼	5	91	19,1	31,5	1"¼	22	¾"	38-46	6/30
S0263S26	¾"x1"¼	5	73	16,2	32,5	1"¼	17,5	¾"	31-46	8/40

Valvola a sfera femmina per contatore gas, con farfalla, sabbiata.

Guarnizione piana in gomma omologata per gas.

Ball valve for gas meter, female, with T-handle. Flat rubber gasket for gas.

#### S0264 OMEGA

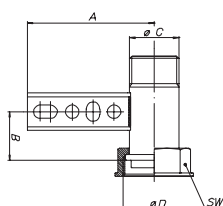

CODICE CODE	MISURA SIZE	PN Bar	A	B	øC	øD	SW	Box Crt
S0264Z20	1"x1"¼	5	85	32,5	1"	1"¼	46	15/30
S0264Z26	¾"x1"¼	5	85	32,5	¾"	1"¼	46	10/20

Canotto con traversa per mensole a sfera per contatori gas, interasse 110mm, zincato.

Tube with crossbar for gas meter brackets, 110 mm axle base, zinc-plated.

#### R1141 OMEGA



ERC

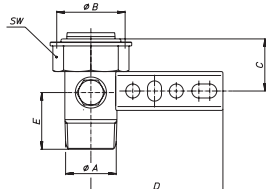

CODICE CODE	MISURA SIZE	PN Bar	ØA	ØB	C	D	E	SW	Box Crt
R1141Z41	1"x1"¼	5	1"	1"¼	32,5	85	36,5	46	4/16

Cannotto con traversa per mensole a sfera per contatori gas, interasse 110mm, con presa 1/4", zincato.  
Tube with crossbar for gas meter brackets, 110 mm axle base, with 1/4" port, zinc-plated.

#### R1152 OMEGA



ERC  
REGULATED

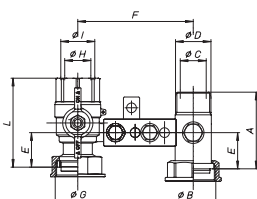

CODICE CODE	MISURA SIZE	PN Bar	A	ØB	ØC	ØD	E	ØF	ØG	ØH	I	L	Box Crt
R1152S20	1"x1"¼	5	71	1"¼	23,5	1"	32,5	110	1"¼	22	1"	82,5	4/16
R1152S26	¾"x1"¼	5	71	1"¼	23,5	1"	32,5	110	1"¼	17,5	¾"	73	4/16

Mensola a sfera per contatore gas, interasse 110mm con zanca per fisher, con presa da 1/4", con farfalla, sabbata. Guarnizione piana in gomma omologata per gas.  
Complete bracket for gas meter, 110 mm axle base, for fisher mounting, with 1/4" port. Flat rubber gasket for gas.

#### S1067 OMEGA



ERC

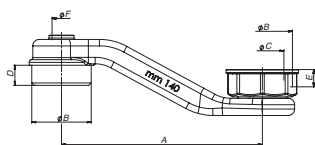

CODICE CODE	MISURA SIZE	PN Bar	A	ØB	C	D	E	ØF	Box Crt
S1067S07	1"x1"¼	5	140	1"¼	30	14	13	¼	8/32

Adattatore per mensole maschio/femmina da mm 110 a 250 con presa PN 1/4".  
Guarnizione piana in gomma omologata per gas.  
Adapter for gas meters with Bar port 1/4". Flat rubber gasket for gas.



### VANTAGGI

Sistema di chiusura sicuro. Sistema di morosità pratico e veloce, che evita il laborioso fissaggio, mediante la tradizionale piombatura con il filo. Due chiavi per l'utente (di colore grigio) fornite insieme alla valvola. Una chiave maestra per il responsabile dell'impianto che funge sia da passepartout che da morosità (di colore giallo) fornita solo a richiesta. N° 100 combinazioni sotto la stessa chiave maestra.

### ADVANTAGES

Safe locking device. Practical and rapid arrearage system which replaces the laborious fixing through the traditional wire-leading. Two grey keys are given to the user together with the valve. The person in charge of the system can receive a master key, which suits all the locks and can be used in case of arrearage. It is a yellow key and it is available only upon request. The same yellow key can be used for 100 different combinations.

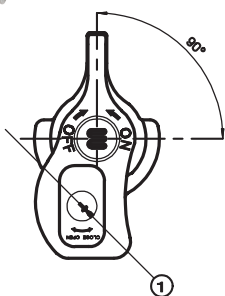

### 1 - POSIZIONE NORMALE

Con la chiave in questa posizione la valvola funziona normalmente ON-OFF e la chiave NON PUÓ essere estratta.

### 1 - NORMAL POSITION

When the key is in this position, the valve works normally ON-OFF and the key itself CANNOT be taken away.

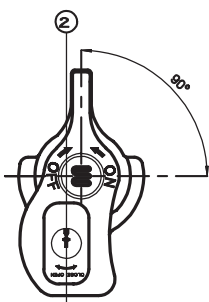

### 2 - POSIZIONE DI BLOCCAGGIO UTENTE

Con la chiave in questa posizione la valvola può essere bloccata in posizione OFF e la chiave PUÓ essere estratta.

### 2 - USER LOCKING POSITION

When the key is in this position, the valve can be locked in the OFF position and the key CAN be taken away.

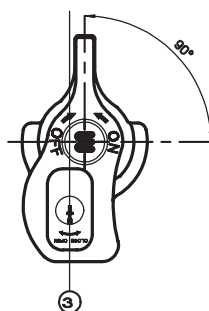

### 3 - POSIZIONE DI MOROSITÀ POSIZIONE ATTIVABILE CON LA SOLA CHIAVE PASSEPARTOUT

Con la chiave in questa posizione la valvola può essere bloccata in posizione OFF e NON PUÓ essere bloccata con la chiave utente. (Chiave gialla in dotazione all'ente erogatore)

### 3 - ARREARAGE POSITION ONLY THE MASTER KEY CAN ACTIVATE THE POSITION

When the key is in this position, the valve can be locked in the OFF position and it CANNOT be locked with the user's key.

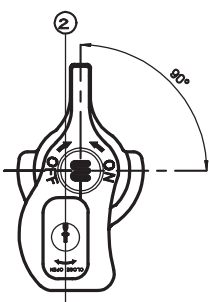

### 4 - RITORNO POSIZIONE NORMALE

Con la chiave riportata in posizione 2 dall'ente erogatore la valvola ritorna a funzionare normalmente.

### 4 - RETURN TO THE NORMAL POSITION

When the key is put back in the second position by the supplier, the valve can work normally.

# OMEGA

## VALVOLA A SFERA A PASSAGGIO TOTALE PER GAS COMBUSTIBILI

### FULL BORE BALL VALVE FOR FUEL GAS

#### R1142 OMEGA

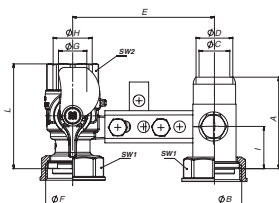

CODICE CODE	MISURA SIZE	PN Bar	A	øB	øC	øD	E	øF	øG	øH	I	L	SW1-2	Box Crt
R1142S41	1"x1 1/4"	5	71	1 1/4"	24	1"	110	1 1/4"	22	1"	32	82,5	45-38	4/16

Tempi di consegna da concordare | Delivery time to be agreed

Mensola a sfera, con serratura di morosità per contatore gas con presa PN, interasse 110mm, sabbata.  
Guarnizione piana in gomma omologata per gas.  
Gas meter bracket, ball valve for gas with Bar gauge port, arrears key-locking device.  
Flat rubber gasket for gas.

#### S1283 OMEGA

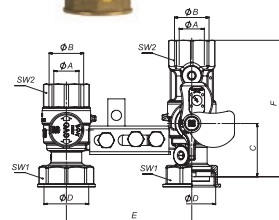

CODICE CODE	MISURA SIZE	PN Bar	øA	øB	C	øD	E	F	SW1-2	Box Crt
S1283S20	1"x1 1/4"	5	22	1"	46,5	1 1/4"	110	120	38-46	4/8

Tempi di consegna da concordare | Delivery time to be agreed

Mensola a doppia valvola con serratura e cappuccio piombabile, presa di PN da 1/4" a monte e a valle della sfera, sabbata. Guarnizione piana in gomma omologata per gas.  
Complete bracket for gas meter, with locking device and plastic head, 1/4" ports upstream and downstream ball. Flat rubber gasket for gas.

#### S1002 OMEGA

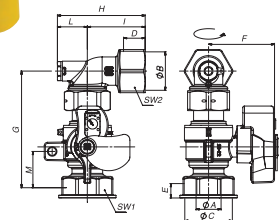
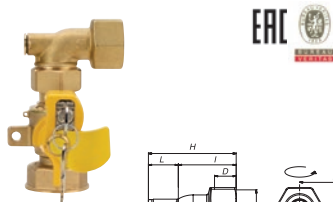

CODICE CODE	MISURA SIZE	PN Bar	øA	øB	øC	D	E	F	G	H	I	L	M	SW1-2	Box Crt
S1002S20	1"x1 1/4" (DN22)	5	22	1"	1 1/4"	19,1	12,7	58	102,5	77,4	51	26,4	32	45-38	2/10

Valvola a sfera per contatore gas con serratura e curva orientabile a 360° con presa PN.  
Guarnizione piana in gomma omologata per gas.  
Ball valve for gas meter, with locking device and adjustable elbow 360°, with 1/4" port.  
Flat rubber gasket for gas.

FINO AD ESAURIMENTO SCORTE | UNTIL STOCK END

#### R1058 OMEGA

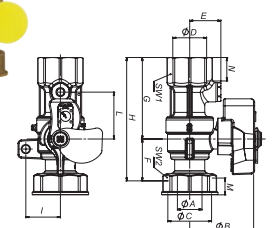
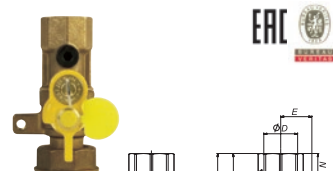

CODICE CODE	MISURA SIZE	PN Bar	øA	B	øC	øD	E	F	G	H	I	L	M	N	SW1-2	Box Crt
R1058S20	1"x1 1/4"	5	22	59	1 1/4"	1"	28	41	82	123	31	52	12,7	19,1	38-45	2/10

Valvola a sfera per contatore gas, con serratura, sabbata, con presa da 1/4" a valle della sfera.  
Guarnizione piana in gomma omologata per gas.  
Ball valve for gas meter, with locking device, with 1/4" port downstream the ball.  
Flat rubber gasket for gas.

#### R1116 OMEGA

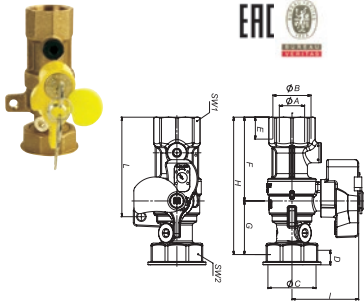

CODICE CODE	MISURA SIZE	PN Bar	ØA	ØB	ØC	D	E	F	G	H	I	L	SW1-2	Box Crt
R1116S20	1"x1"¼	5	22	1"	1"¼	12,7	19,1	72	45,5	118,5	51	86	38-45	2/10

Valvola a sfera per contatore gas, con serratura, sabbata, con presa da 1/4" a monte e a valle della sfera.  
Guarnizione piana in gomma omologata per gas.  
Ball valve for gas meter, with locking device, with 1/4" port upstream and downstream the ball.  
Flat rubber gasket for gas.

#### S0268 OMEGA

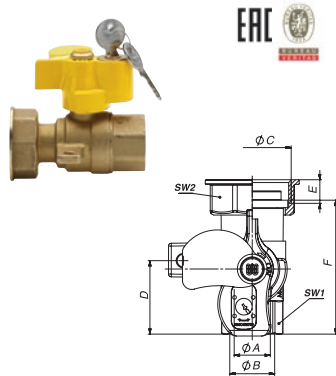

CODICE CODE	MISURA SIZE	PN Bar	ØA	ØB	ØC	ØD	E	F	SW1-2	Box Crt
S0268S20	1"x1"¼	5	22	1"	1"¼	50,5	12,7	82,5	38-45	4/20

Valvola a sfera femmina per contatore gas con serratura di morosità con farfalla, sabbata.  
Guarnizione piana in gomma omologata per gas.  
Ball valve for gas meter, female, with key-locking device. Flat rubber gasket for gas.

#### S3269 OMEGA

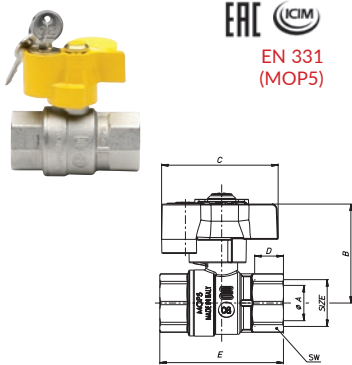

CODICE CODE	MISURA SIZE	PN Bar	A	B	C	D	E	SW	Box Crt
S3269N35	¾"	30	20	56	66	16,3	73,5	31	6/30
S3269N36	1"	30	25	60	66	19,1	86,5	38	6/30

Tempi di consegna da concordare | Delivery time to be agreed

Valvola a sfera femmina/femmina a passaggio totale per gas combustibili con serratura di morosità, con farfalla, nichelata.  
Full bore ball valve for fuel gas, female/female, with key-locking device, with T-handle, nickel-plated.

#### S3278 OMEGA

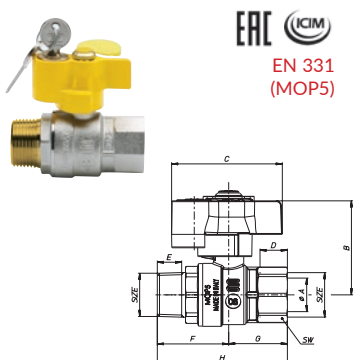

CODICE CODE	MISURA SIZE	PN Bar	A	B	C	D	E	F	G	H	SW	Box Crt
S3278N35	¾"	30	20	56	66	16,3	14,5	42,5	35	77,5	31	6/30
S3278N36	1"	30	25	60	66	19,1	16,8	47,5	42,5	89	38	6/24

Tempi di consegna da concordare | Delivery time to be agreed

Valvola a sfera maschio/femmina a passaggio totale per gas combustibili con serratura di morosità, con farfalla, nichelata.  
Full bore ball valve for fuel gas, male/female, with key-locking device, with T-handle, nickel-plated.

#### S0271 OMEGA

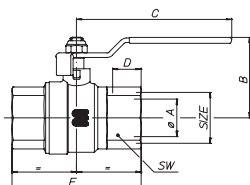

CODICE CODE	MISURA SIZE	PN Bar	øA	B	C	D	E	SW	Box Crt
S0271N32	¼" (DN10)	80	10	37	90	11	47,5	17	20/100
S0271N33	⅜" (DN 10)	80	10	37	90	11,4	49,5	21	20/100
S0271N34	½" (DN15)	80	15	41,7	90	15	65	26	12/60
S0271N35	¾" (DN20)	80	20	49,8	105	16,3	73,5	32	12/48
S0271N36	1" (DN 25)	80	25	53,8	105	19,1	86,5	39	8/32
S0271N37	1"¼ (DN32)	64	32	63,2	120	21,4	101,5	48	4/20
S0271N38	1"½ (DN40)	64	40	72	140	21,4	115,5	55	4/8
S0271N39	2" (DN50)	64	50	83,7	170	25,7	132,5	68	2/4
S0271N40	2" ½ (DN65)	40	65	99,5	170	30,2	158	83	1/5
S0271N41	3" (DN80)	25	80	113,2	250	33,3	182,5	97	1/2
S0271N42	4" (DN100)	16	100	139	250	39,3	219	124	1/1

Valvola a sfera femmina/femmina a passaggio totale per gas combustibili con leva in acciaio gialla, nichelata.  
Full bore ball valve for fuel gas with steel lever, female/female, nickel-plated

#### S0277 OMEGA

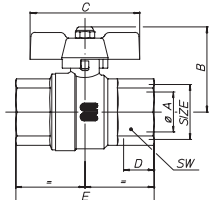

CODICE CODE	MISURA SIZE	PN Bar	øA	B	C	D	E	SW	Box Crt
S0277N32	¼" (DN10)	80	10	35	52	11	47,5	17	30/150
S0277N33	⅜" (DN 10)	80	10	35	52	11,4	49,5	21	28/140
S0277N34	½" (DN15)	80	15	40,5	52	15	65	26	15/75
S0277N35	¾" (DN20)	80	20	49,5	65	16,3	73,5	32	12/48
S0277N36	1" (DN 25)	80	25	54	65	19,1	86,5	39	9/27

Valvola a sfera femmina/femmina a passaggio totale per gas combustibili con farfalla gialla, nichelata.  
Full bore ball valve for fuel gas with T-handle, female/female, nickel-plated.

#### S0278 OMEGA

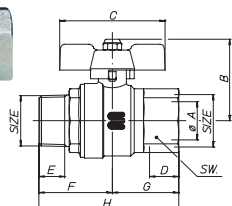
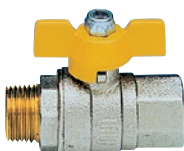

CODICE CODE	MISURA SIZE	PN Bar	øA	B	C	D	E	F	G	H	SW	Box Crt
S0278N32	¼" (DN10)	80	10	35	52	11	9,7	30,75	23,75	54,5	17	30/150
S0278N33	⅜" (DN 10)	80	10	35	52	11,4	10,1	31,25	24,75	56	21	28/140
S0278N34	½" (DN15)	80	15	40,5	52	15	13,2	38	32,5	70,5	26	15/75
S0278N35	¾" (DN20)	80	20	49,5	65	16,3	14,5	42,25	36,75	79	32	12/48
S0278N36	1" (DN 25)	80	25	54	65	19,1	16,8	47,75	43,25	91	39	9/27

Valvola a sfera maschio/femmina a passaggio totale per gas combustibili con farfalla gialla, nichelata.  
Full bore ball valve for fuel gas with T-handle, male/female, nickel-plated.

#### S0282 - S0284 OMEGA

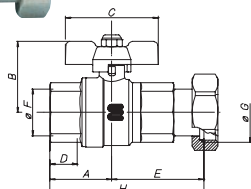
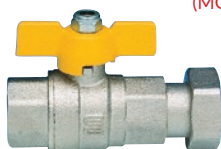

CODICE CODE	MISURA SIZE	PN Bar	A	B	C	D	E	øF	øG	H	Box Crt
S0284N36	½"x¾" (DN15)	16	32,5	41,7	52	15	48	½	¾	65,5	12/60
S0284N38	¾"x1" (DN20)	16	36,75	49,8	65	16,3	53,25	¾	1"	90	9/36
S0284N39	¾"x1" ¼ (DN20)	16	36,75	49,8	31	16,3	61,75	¾	1" ¼	98,5	8/31
S0282N37	¾"x¾" (DN20)	80	43,25	53,8	65	19,1	66,25	1"	1" ¼	108,5	12/60

Tempi di consegna da concordare | Delivery time to be agreed

Valvola a sfera a passaggio totale per gas combustibili femmina con farfalla per contatori, nichelata.  
Full bore ball valve for fuel gas with T-handle or steel lever, female/nut, nickel-plated.



#### S0283 - S0285 OMEGA

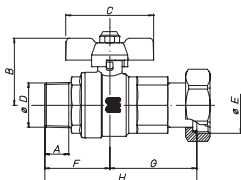

CODICE CODE	MISURA SIZE	PN Bar	A	B	C	øD	øE	F	G	H	Box Crt
S0285N36	1/2"x3/4" (DN15)	16	13,2	41,7	52	1/2	3/4	38	38	86	12/60
S0283N37	3/4"x3/4" (DN20)	80	14,5	49,8	65	3/4	1"	42,25	52,25	95,5	12/60
S0285N38	3/4"x1" (DN20)	16	14,5	49,8	65	3/4	1 1/4	42,25	61,75	104	9/36

Tempi di consegna da concordare | Delivery time to be agreed

Valvola a sfera a passaggio totale per gas combustibili maschio con farfalla per contatori, nichelata.  
Full bore ball valve for fuel gas with T-handle or steel lever, male/nut, nickel-plated.

#### S0286 OMEGA

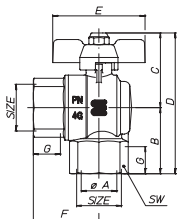

CODICE CODE	MISURA SIZE	PN Bar	øA	B	C	D	E	F	G	SW	Box Crt
S0286N34	1/2"x1/2" (DN15)	40	15	33	39,5	72,5	52	31,5	15	26	16/80
S0286N35	3/4"x3/4" (DN20)	40	20	39	48,5	87,5	65	35	16,3	32	12/48
S0286N36	1"x1" (DN25)	40	25	46,5	52	99,5	65	41,5	19,1	39	8/32

Valvola a sfera per gas combustibili a passaggio totale femmina/femmina a squadra, con farfalla, nichelata.  
Angle full bore valve for fuel gas with T-handle, female/female, nickel-plated.

#### S0287 OMEGA

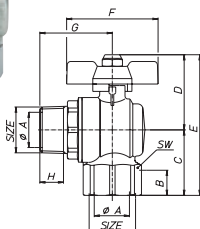

CODICE CODE	MISURA SIZE	PN Bar	øA	B	C	D	E	F	G	H	SW	Box Crt
S0287N34	1/2"x1/2" (DN15)	40	15	15	33	39,5	72,5	52	38,5	13,3	26	16/80
S0287N35	3/4"x3/4" (DN20)	40	20	16,3	39	48,5	87,5	65	44,5	14,5	32	12/48
S0287N36	1"x1" (DN25) ◆	40	25	18,1	46,5	53	99,5	65	51,5	16,8	39	8/32

Tempi di consegna da concordare | Delivery time to be agreed

Valvola a sfera per gas combustibili femmina/maschio a squadra passaggio totale, con farfalla, nichelata.  
Angle full bore ball valve for fuel gas with T-handle, male/female, nickel-plated.

#### S0288 OMEGA

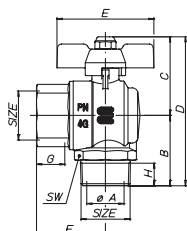

CODICE CODE	MISURA SIZE	PN Bar	øA	B	C	D	E	F	G	H	SW	Box Crt
S0288N34	1/2"x1/2" (DN15)	40	15	33,5	39,5	73	52	31,5	15	11,5	26	16/80
S0288N35	3/4"x3/4" (DN20)	40	20	39,5	48,5	88	65	35	16,3	12,9	32	12/48
S0288N36	1"x1" (DN25)	40	25	47	53	100	65	41,5	19,1	14,7	39	8/32

Valvola a sfera a passaggio totale per gas combustibili maschio/femmina a squadra, con farfalla, nichelata.  
Angle full bore ball valve for fuel gas with T-handle, male/female, nickel-plated.

### S0289 OMEGA

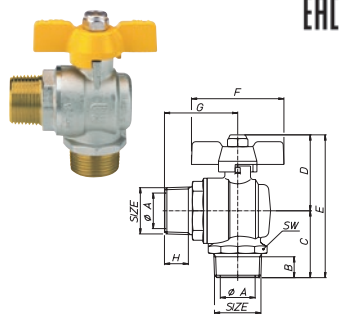

CODICE CODE	MISURA SIZE	PN Bar	øA	B	C	D	E	F	G	H	SW	Box Crt
S0289N34	1/2"x1/2" (DN15)	40	15	11,5	33,5	39,5	73	52	38,5	13,2	26	16/80
S0289N35	3/4"x3/4" (DN20)	40	20	12,9	39,5	48,5	88	65	44,5	14,5	32	12/48
S0289N36	1"x1" (DN25)	40	25	14,7	47	53	100	65	51,5	16,8	39	8/32

Valvola a sfera per gas combustibili maschio/maschio a squadra passaggio totale, con farfalla, nichelata.  
Angle full bore ball valve for fuel gas with T-handle, male/male, nickel-plated.

### S0290 OMEGA

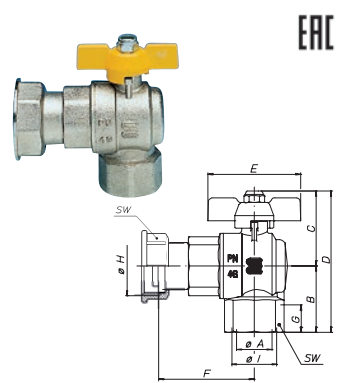

CODICE CODE	MISURA SIZE	PN Bar	øA	B	C	D	E	F	G	øH	øI	SW	Box Crt
S0290N38	3/4"x1" (DN20)	40	20	39	48,5	87,5	65	51,5	16,3	1"	3/4"	32	8/32
S0290N39	3/4"x1" 1/4 (DN20)	40	20	39	48,5	87,5	65	61	16,3	1" 1/4	3/4"	32	8/32
S0290N41	1"x1" 1/4 (DN25)	40	25	46,5	52	99,5	65	64,5	19,1	1" 1/4	1"	39	6/24

Tempi di consegna da concordare | Delivery time to be agreed

Valvola a sfera a passaggio totale per gas combustibili femmina, a squadra per contatore, con farfalla, nichelata.  
Angle full bore ball valve for fuel gas with T-handle, female/nut, nickel-plated.

### G0055 OMEGA

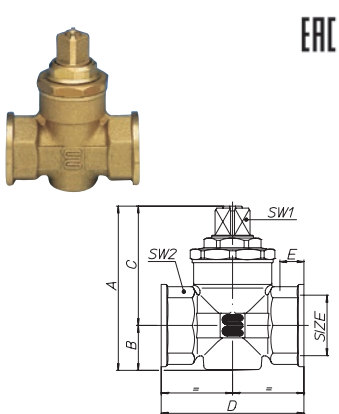

CODICE CODE	MISURA SIZE	PN Bar	A	B	C	D	E	SW1-2	Box Crt
G0055S04	1/2" (DN15)	1,5	64,5	15,5	49	57	9,7	12-25	12/60
G0055S05	3/4" (DN20)	1,5	73	19	54	64	11,2	12,5-31	12/48
G0055S06	1" (DN 25)	1,5	85,5	23	62,5	75	12,7	14,5-38	8/32
G0055S07	1" 1/4 (DN32)	1,5	102,5	31	71,5	92	13,7	19-47,5	4/20
G0055S08	1" 1/2 (DN40)	1,5	109,75	33,5	76,25	102	15,7	19-54	4/8
G0055S09	2" (DN50)	1,5	127,5	39,5	88	122	17,7	24-66	2/8

Rubinetto a maschio conico femmina/femmina con quadro, sabbiato.  
Tapered plug for fuel gas and water with square head, female/female.

