

BIBO

RUBINETTO A SFERA CURVO ANGLE BALL COCK



SPECIFICA MATERIALI MATERIAL SPECIFICATION

PARTICOLARI COMPONENT COMPONENT

MATERIALI MATERIAL

DESCRIZIONE DESCRIPTION

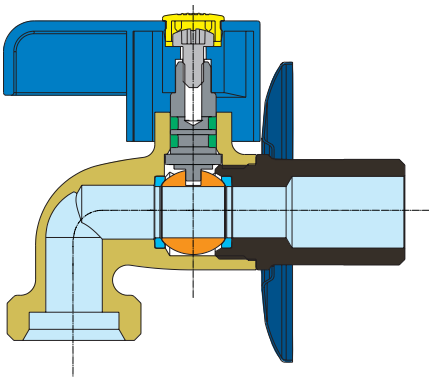

 CORPO BODY	CW 617 N UNI EN 12165	STAMPATO DA BARRA, NICHELATO Forged, Nickel-Plated
 MANICOTTO END ADAPTER	CW 617 N UNI EN 12165	STAMPATO DA BARRA, NICHELATO Forged, Nickel-Plated
 SFERA BALL	CW 614 N UNI EN 12164	DA BARRA, NICHEL-CROMATA Machined, Chrome-Plated
 SEDI LATERALI BALL GASKETS	PTFE	VERGINE Virgin
 PERNO STEM	CW 614 N UNI EN 12164	DA BARRA Machined
 O-RINGS	ELASTOMERO Elastomer	ADATTO ALL'USO PER ACQUA Suitable For Use With Water
 LEVA HANDLE	PLASTICA	PLASTIFICATA CROMATA Plastic Chrome-Plated
 VITE SCREW	ACCIAIO Steel	ZINCATA Zinc-Plated
 ROSONE LOCK SHIELD	ACCIAIO INOX Stainless Steel	CROMATO Chrome-Plated
 TAPPO PLUG	PLASTICA Plastic	STAMPATO MOLDED

FILETTATURE Estremità filettate UNI ISO 228/1.

END CONNECTIONS Threaded ends UNI ISO 228/1.

IMPIEGHI Acqua fredda e calda, aria compressa, oli, fluidi non corrosivi, benzine. Per impieghi particolari vedere la tabella delle resistenze chimiche.

APPLICATIONS Hot and cold water, compressed air, oils, non corrosive fluids, fuels. For any special uses see the table of chemical resistance.

PRESSIONE DI ESERCIZIO Max PN16. Vedere diagramma pressione/temperatura.

PRESSURE LIMITS PN 16 max. See pressure/temperature diagram.

LIMITI DI TEMPERATURA Da -20°C a +90°C. Vedere diagramma pressione/temperatura.

TEMPERATURE LIMITS From -20°C to + 90°C. See pressure/temperature diagram.

Diagramma pressione/temperatura (prova eseguita con acqua)
Pressure/temperature diagram (tested with water)



Diagramma perdite di carico (prova eseguita con acqua)
Loss of head diagram (tested with water)



S0121 BIBO PLUS

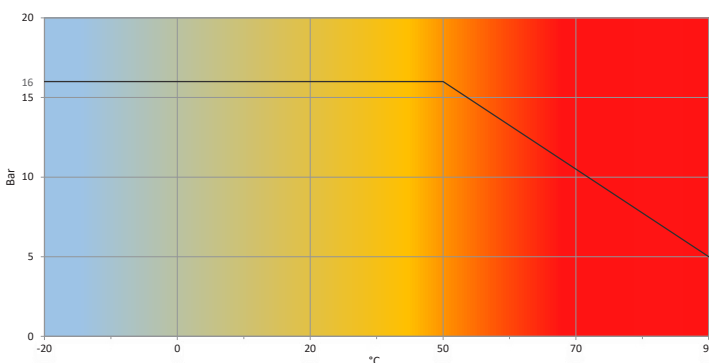
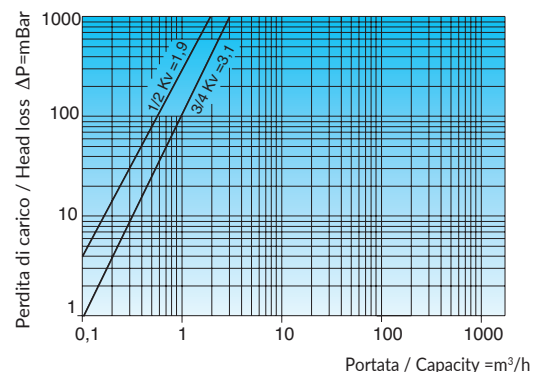

ERAC

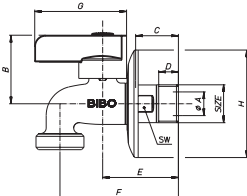

CODICE CODE	MISURA SIZE	PN Bar	øA	øB	C	D	E	F	G	H	SW	Box Crt
S0121C04	1/8"	16	10	37,5	25,5	10,2	41	64,5	50	58	18	10/50

Rubinetto a sfera curvo, attacco per portagomma con levetta e rosone, con chiave di avvitamento a muro, cromato lucido.
Angle ball bib cock, with coupling for hose connector, with lever and lock shield, with a spanner for screwing it to the wall, polished chrome-plated.

S0030 BIBO



ERAC

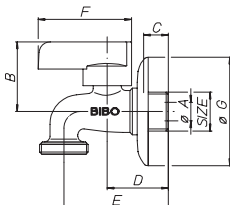

CODICE CODE	MISURA SIZE	PN Bar	øA	B	C	D	E	F	Box Crt
S0030N03	3/8"	16	10	37,5	14,6	33	56	50	24/96
S0030N04	1/2"	16	10	37,5	14,6	33	56	50	24/96

Rubinetto a sfera curvo, fil. maschio attacco per portagomma con levetta bianca, nichelato.
Ball bib cock for washing machines, nickel-plated.

S0031 BIBO LUX



ERAC

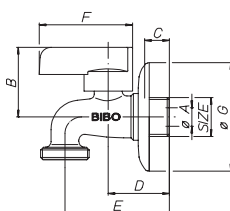

CODICE CODE	MISURA SIZE	PN Bar	øA	B	C	D	E	F	Box Crt
S0031C03	3/8"	16	10	37,5	14,6	33	56	50	12/60
S0031C04	1/2"	16	10	37,5	14,6	33	56	50	12/60

Rubinetto a sfera curvo, attacco per portagomma con levetta e rosone, cromato lucido.
Angle ball bib cock, with coupling for hose connector, with lever and lock shield, polished chrome-plated.

S0032 BIBO



ERAC

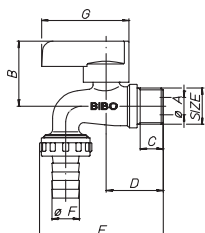

CODICE CODE	MISURA SIZE	PN Bar	øA	B	C	D	E	øF	G	Box Crt
S0032N03	3/8"	16	10	37,5	15	33	71	16	50	12/60
S0032N04	1/2"	16	10	37,5	15	33	71	16	50	20/80

Rubinetto a sfera curvo, con portagomma con levetta bianca, nichelato.
Angle ball bib cock, and hose connector, with white lever, nickel-plated.

S0033 BIBO LUX



ERAC

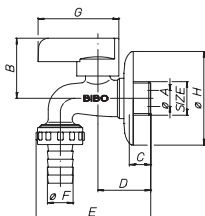

CODICE CODE	MISURA SIZE	PN Bar	øA	B	C	D	E	øF	G	øH	Box Crt
S0033C03	3/8"	16	10	37,5	14,6	33	71	16	50	58	12/60
S0033C04	1/2"	16	10	37,5	14,6	33	71	16	50	58	12/48

Rubinetto a sfera curvo, con portagomma con levetta e rosone, cromato lucido.
Angle ball bib cock, and hose connector, with lever and lock shield, polished chrome-plated.

S0034C BIBO LUX



ERAC

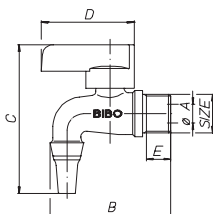

CODICE CODE	MISURA SIZE	PN Bar	øA	B	C	D	E	Box Crt
S0034C03	3/8"	16	10	65	80	50	14,6	12/60
S0034C04	1/2"	16	10	65	80	50	14,6	12/60

Rubinetto a sfera curvo per botti, con bocchello, con levetta, cromato lucido.
Angle ball bib cock for wooden casks, and nozzle, with lever, polished chrome-plated.

S0034N BIBO



ERAC

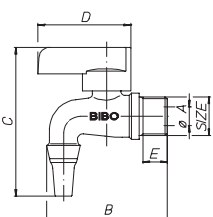

CODICE CODE	MISURA SIZE	PN Bar	øA	B	C	D	E	Box Crt
S0034N03	3/8"	16	10	65	80	50	14,6	24/96
S0034N04	1/2"	16	10	65	80	50	14,6	24/96

Rubinetto a sfera curvo per botti, con bocchello, con levetta bianca, nichelato.
Angle ball bib cock for wooden casks, and nozzle, with white lever, nickel-plated.

S0039 BOLA



ERAC

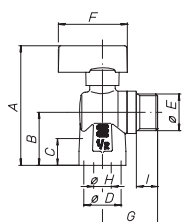

CODICE CODE	MISURA SIZE	PN Bar	A	B	C	øD	øE	F	G	øH	øI	Box Crt
S0039N04	1/2" (DN10)	16	68,7	30	17	1/2"	1/2"	39	31,2	10	12	20/100

Rubinetto a sfera curvo, fil. maschio attacco per portagomma con levetta bianca, nichelato.
Ball bib cock for washing machines, nickel-plated.

S0041 BOLA



ERAC

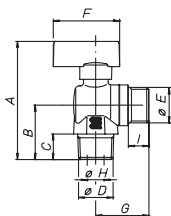

CODICE CODE	MISURA SIZE	PN Bar	A	B	C	ØD	ØE	F	G	ØH	Box Crt
S0041N04	½" x ½" (DN10)	-	70,8	32	15	½"	½"	39	31,2	10	20/100
S0041N18	¾" x ½" (DN10)	-	71,1	32,3	12,5	¾"	½"	39	31,2	10	20/100

Rubinetto a sfera a squadra maschio/maschio con levetta cromata, nichelato.
Angle ball bib cock, male/male with chrome-plated lever, nickel-plated.

S0045



ERAC

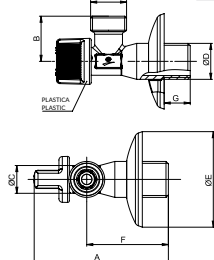

CODICE CODE	MISURA SIZE	PN Bar	A	ØB	ØC	ØD	ØE	F	G	ØH	ØI	Box Crt
S0045C04	½" x ½"	10	77	26	16	½"	55	47	15	-	½"	30/240
S0045C18	¾" x ½"	10	52	27	25	½"	57	22	15,6	9	¾"	20/160

Rubinetto a sfera per lavatrice in ottone cromato, completo di rosone.
Ball bib cock for washing-machines in chrome-plated brass, equipped with lock shield.

S0125



ERAC

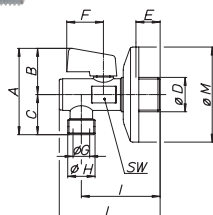

CODICE CODE	MISURA SIZE	PN Bar	A	B	C	ØD	E	F	ØG	ØH	ØI	L	ØM	Box Crt
S0125C03	¾" x ½"	-	52	27,5	24,5	⅛"	15	22	14	⅛"	47	60	55	10/50

Rubinetto a sfera sotto-lavabo, cromato, senza snodo sferico.
Undersink bib-cock, chrome plated, without ball joint.

S0126



ERAC

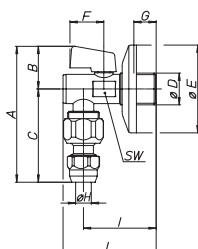

CODICE CODE	MISURA SIZE	PN Bar	A	B	C	ØD	E	F	G	ØH	ØI	L	SW	Box Crt
S0126C93	½" x 10	-	88	27,5	60,5	⅛"	55	22	14,2	10,2	47	60	19	60/60

Rubinetto a sfera sotto-lavabo, cromato, con snodo sferico.
Undersink bib-cock, chrome plated, with ball joint.

S0128



ERA

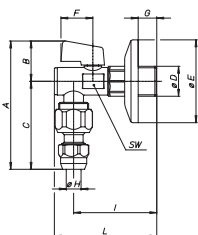

CODICE CODE	MISURA SIZE	PN Bar	A	B	C	ØD	E	F	G	ØH	ØI	L	SW	Box Crt
S0128C93	1/2"x10	-	88	27,5	60,5	1/8"	55	22	15	10,2	47	70	19	60/60

Rubinetto a sfera sotto-lavabo, cromato, con snodo sferico, versione lunga.
Undersink bib-cock, chrome plated, with ball joint, long version.

S0048 COMBI



ERA

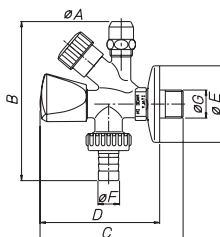

CODICE CODE	MISURA SIZE	PN Bar	A	B	C	D	ØE	ØF	G	Box Crt
S0048C18	1/2"x 3/4"	-	10	116	105	87	56	15	1/2"	30/30

Rubinetto combinato sottolavabo attacco lavatrice.
Undersink combined tap with washing machine connection.

